

1080p / 1080p IR / 4K / 4K IR PTZ Camera

Installation Manual



24/7 Support

Your purchase of this TrueLook system includes customer and technical support. If you have any questions regarding the use or configuration of this equipment and software, please don't hesitate to contact us.

Phone 833.878.3566

Email support@truelook.com

Office 575 4th Street E, Winston Salem, NC 27101

Online Resources

Use this QR code or visit truelook.com/install to access:

- 1 An admin guide to walk you through creating your time-lapses and other administrative settings.
- 2 Video demonstrations of installation procedures.
- 3 A digital PDF of this install guide.
- 4 Download links for the TrueLook mobile app.
- 5 Other helpful resources.



For Terms & Conditions as well as Warranty information, visit truelook.com/terms-conditions.

Hardware Packing List

Camera System and Enclosure

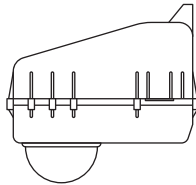

1080p & 4K Models

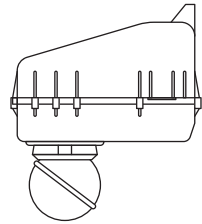

1080p IR & 4K IR Models

Pole Mounting Bracket and Steel Straps

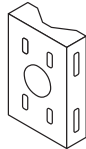

x1

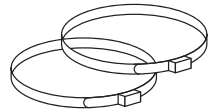

x2

Mounting Hardware

Assorted hardware for securing your camera.



Bolts



Screws

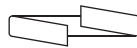

Lock Washers



Flat Washers

Solar units will also include panel(s), battery, and battery housing. These are shipped separately.

Powering the Camera System to Verify Operation

Before getting started, power your system to verify proper operation before installation. It is easier to troubleshoot an issue before it's installed in its final location.

You may log in to your camera at app.truelook.cloud using your unique username and password located on the back cover of this guide.

Pole Mounting

STEP 01

Feed straps through mounting bracket.

Cameras include pole brackets with two strap options based on the pole diameter (see diagram).

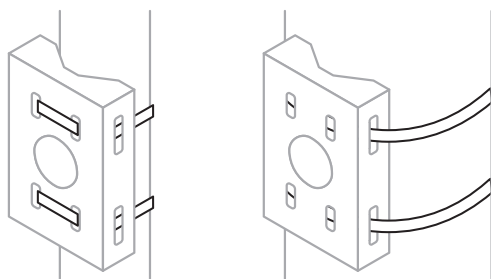

Small Diameter

Large Diameter

With your bracket aimed toward the center of your jobsite, tighten the straps securely using drill with size 5/16 Hex driver bit (not included).

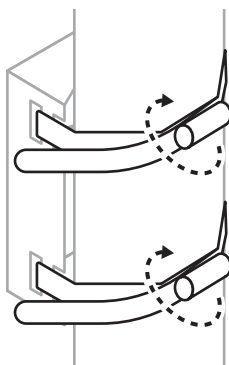

MOUNTING

STEP 02

Place two lower bolts into mounting bracket.

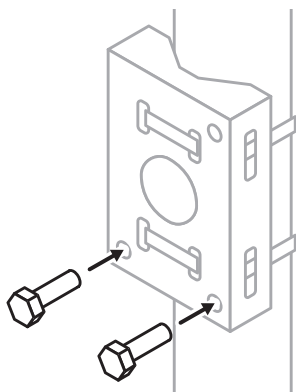

Hardware
Needed

x2

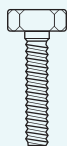

STEP 03

Slide the enclosure's lower keyhole slots onto two bolts (green arrow).

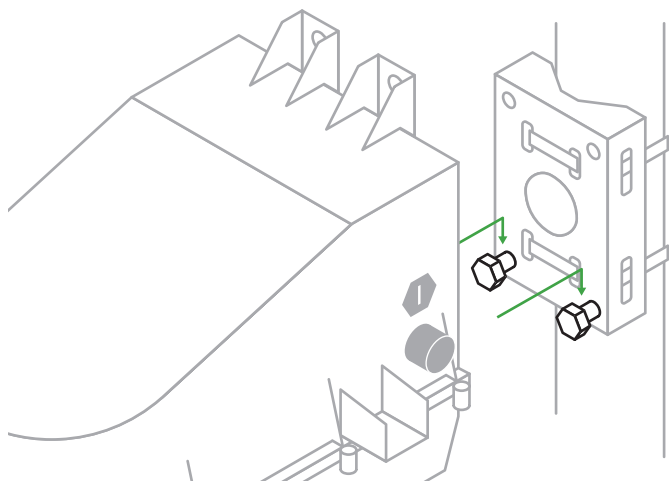

MOUNTING

STEP 04

Install upper bolts to fully secure enclosure to mounting bracket.

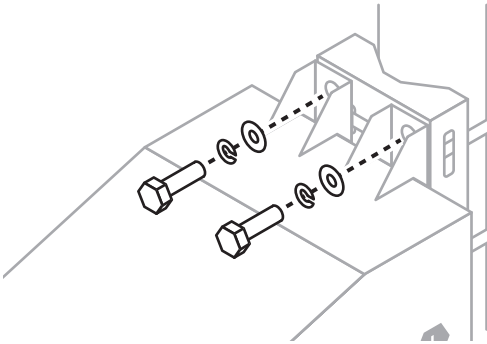

Create a drip loop to avoid gravity-driven moisture entering enclosure



Hardware Needed

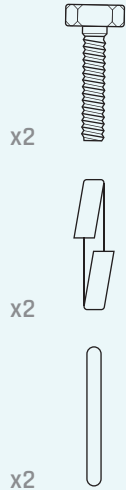

SOLAR MODULE USERS: AT THIS POINT, PLEASE PROCEED TO THE “SOLAR MODULES INSTALLATION MANUAL” AND FOLLOW THE INSTRUCTIONS THROUGH THE END OF THE GUIDE.

STEP 05

Remove protective covering from camera lens and supply power. Your camera will be online and ready to use within 10 minutes.

Wall Mounting

STEP 01

Hold camera up to about five inches lower than desired place on wall and mark the upper screw holes of enclosure on surface.

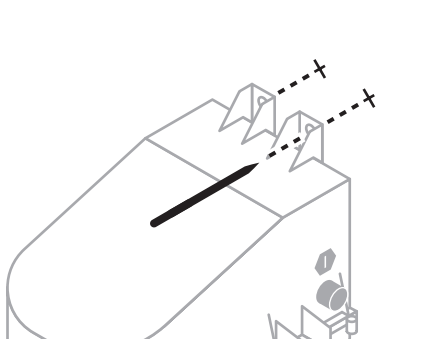

STEP 02

Place bolts (not included) into marked locations.

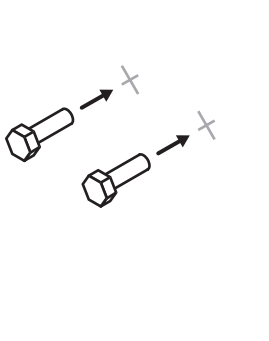

MOUNTING

STEP 03

Slide the enclosure's lower keyhole slots onto two bolts (green arrow).

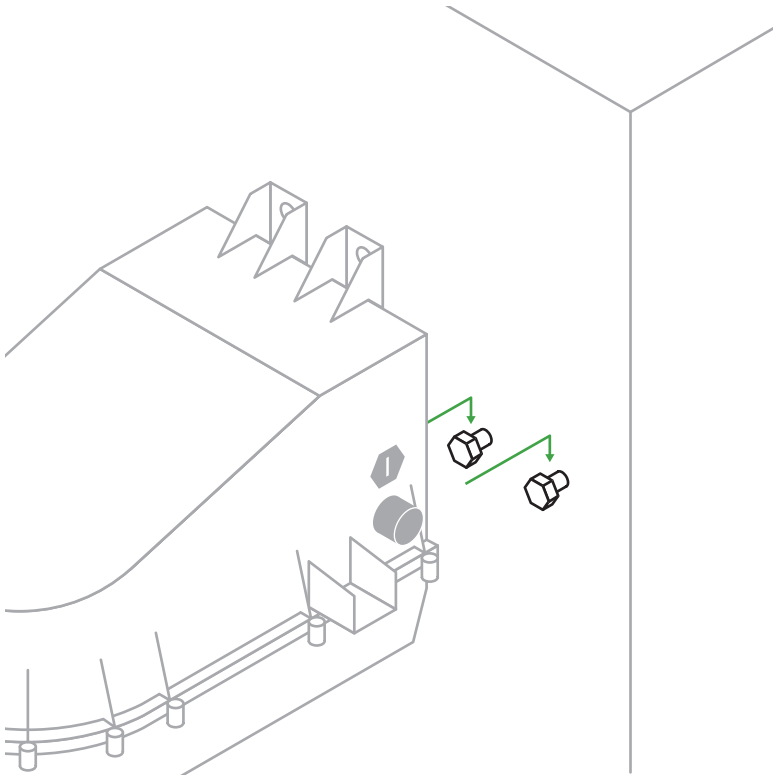

MOUNTING

STEP 04

Using hardware appropriate for your mounting surface, install upper bolts to fully secure enclosure to wall.

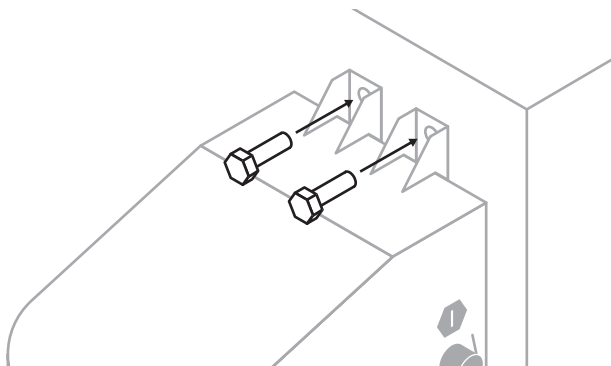

Create a drip loop to avoid gravity-driven moisture entering enclosure

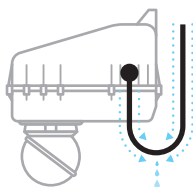

SOLAR MODULE USERS: AT THIS POINT, PLEASE PROCEED TO THE “SOLAR MODULES INSTALLATION MANUAL” AND FOLLOW THE INSTRUCTIONS THROUGH THE END OF THE GUIDE.

STEP 05

Remove protective covering from camera lens and supply power. Your camera will be online and ready to use within 10 minutes.

One Last Step!

Did you know that our support team offers a free installation review?

Once you're done, simply snap a few pictures and email them to support@truelook.com. If we notice anything that we can help with, we'll reach out. This will also help our support team quickly view your setup if you run into equipment issues at any point in the future.

THE EMAIL

For the most efficient response from our team, include the following in your email:

- 1 Company Name
- 2 Project Name
- 3 Contact person for installation issues
- 4 The following photographs:
 - a) Your whole TrueLook solution: the camera, what it's mounted to, and any accessories (such as solar panels)
 - b) Close-ups of mounting
 - c) Close-ups of connections
 - d) Inside control box, if applicable (this is especially helpful for solar panels, solar skids, and mobile trailers)

Your Unique Login



TRU24019-0702